

Module position:

- 1 On the heat/cooling source
- 2 On the heat/cooling source or on the wall
- 3 In the station
- 4 In the station or on the wall
- 5 On the wall
- 6 In the controller

The system schematic shown is a non-binding schematic diagram. The circuit diagram/connection diagram contains details on the electrical wiring. Observe national and regional regulations, technical rules and guidelines.

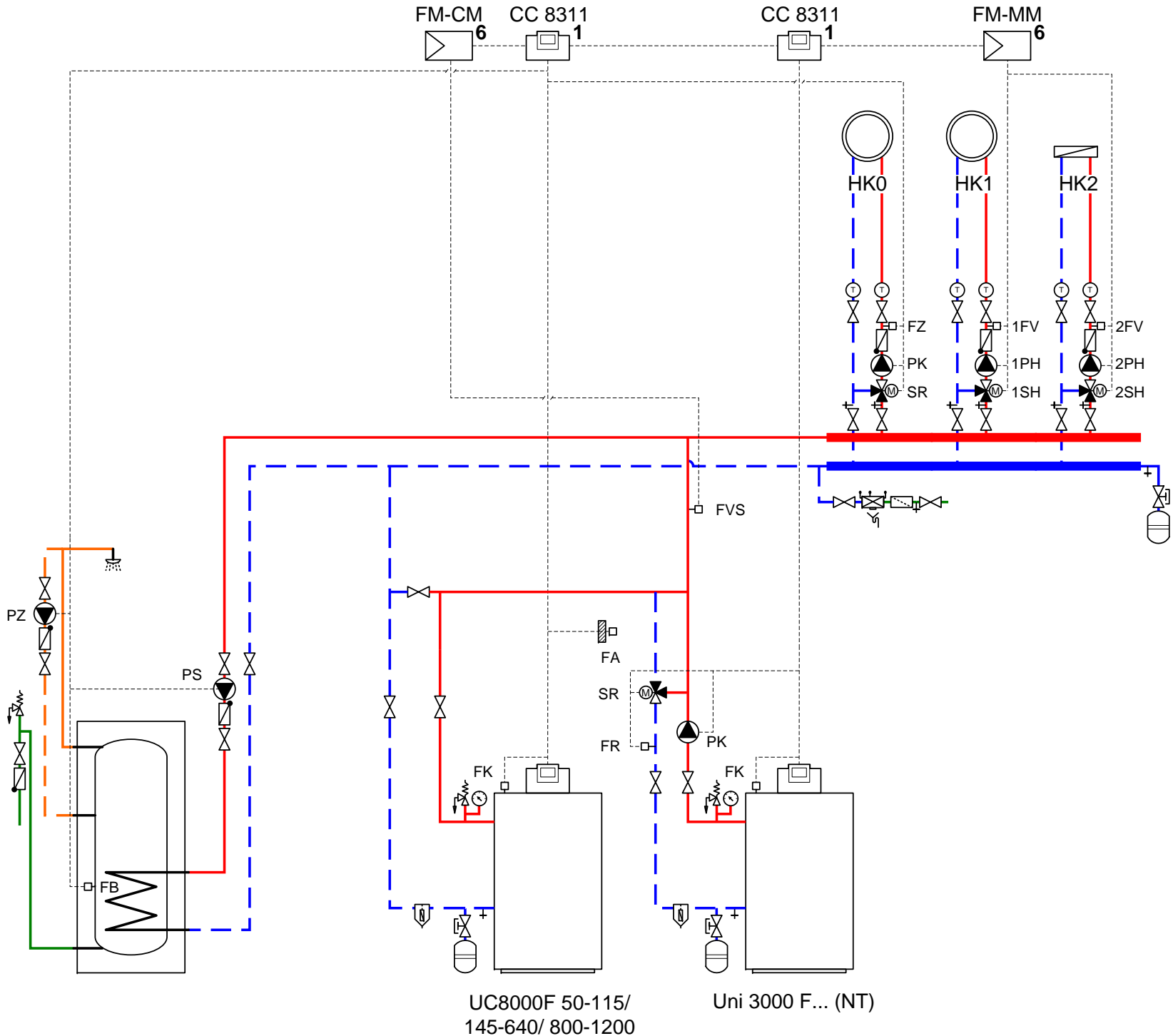

No. 6721836186

State 17.03.2021

**Bosch**

### Explanation of symbols

Symbol	Name	Symbol	Name	Symbol	Name
<b>Pipework/cables</b>					
	Flow - heating/solar		Brine return		DHW circulation
	Return - heating/solar		Potable water		Electrical wiring
	Brine flow		DHW		Electrical wiring with break
<b>Mixing valves/valves/temperature sensors/pumps</b>					
	Valve		Pressure differential controller		Pump
	Inspection bypass		Pressure relief valve		Non-return valve
	Flow regulating valve		Safety assembly		Temperature sensor/switch
	Pressure relief valve		3-way mixing valve (mixing/distribution)		Safety temperature limiter
	Filter shut-off valve		DHW mixer, thermostatic		Flue gas temperature sensor/switch
	Cap valve		3-way mixing valve (changeover)		Flue gas temperature limiter
	Valve, mechanically controlled		3-way mixing valve (change over, de-energised when closed to II)		Outside temperature sensor
	Valve, thermally controlled		3-way mixing valve (change over, de-energised when closed to A)		Wireless outside temperature sensor
	Shut-off valve, magnetically controlled		4-way mixing valve		...wireless...
<b>Miscellaneous</b>					
	Thermometers		Drain outlet with siphon		Low loss header with sensor
	Manometer		System separation according to EN1717		Heat exchanger
	Drain & fill valve		Expansion vessel with cap valve		Flow rate measuring device
	Water filter		Magnetite separator		Tundish
	Heat meter		Air separator		Heating circuit
	DHW outlet		Automatic air vent		Underfloor heating circuit
	Relay		Expansion joint		Low loss header
	Immersion heater				

### Descriptions

KR	Flow-check valve
PK	Boiler circuit pump
RK	Return
VK	Flow
VSL	Safety flow
SR	Actuator, return temperature raising facility
SV	Pressure relief valve
SK	Boiler circuit actuator
SH	Heating circuit actuator
VHK	Heating circuit flowrate
VPK	Boiler circuit pump flow rate
TWH	Flow temperature limiter
DV	Throttle valve
FA	Outside temperature sensor
FK	Boiler temperature sensor
FV	Flow temperature sensor
FB	DHW temperature sensor
FZ	Auxiliary temperature sensor
FVS	Strategy sensor
FR	Return temperature sensor
PK	Boiler circuit pump
PH	Heating circuit actuator
PS	Cylinder primary pump
PZ	DHW circulation pump

### Low loss header

A low loss header (hydraulic balancing) is used to hydraulically separate the boiler circuit and the heating circuits.

Installing a low loss header brings many benefits:

- Sizing boiler circuit pump and actuators is easy. Interaction between the heating water flow inside the boiler and in the heat consumer circuits is prevented. Boiler and heat consumers are only supplied with the assigned water flow.
- May be used in single and multi-boiler systems, subject to the heating circuit control system.
- Actuators on both sides of the low loss header provide optimum operation if they are sized correctly. The hydraulic balancing line can also be used as a sludge trap, subject to being sized correctly.
- Where there is a large pressure drop on the water side and large distances between boiler and heating circuits, a split into primary and secondary side is possible.

### Sizing the low loss header

Correct sizing is crucial to the function of the low loss header. To ensure good separation with the simultaneous function as a dirt separator, size the line in such a way that there is virtually no pressure drop between the flow and return. At the nominal amount of water, a flow velocity of 0.1 m/s to 0.2 m/s can be expected. This also enables the simultaneous use as a sludge trap. To be able to capture the heating circuit flow temperature, provide a sensor well of 200 mm to 300 mm length in the upper area of the hydraulic balancing line on the heating circuit side.

$$D = \sqrt[4]{\frac{\dot{V}_{Kges}}{v} \times \frac{1}{2827}}$$

*Calculating the size of the low loss header*

D	Diameter of the hydraulic balancing line in m
v	Flow velocity in m/s
$\dot{V}_{Kges}$	Total boiler circuit flow rate in m <sup>3</sup> /h

### Example

Given:

- Total flow rate  $\dot{V}_{Kges} = 223.6 \text{ m}^3/\text{h}$
- Flow velocity (assumption)  $v = 0.2 \text{ m/s}$

Result:

- Diameter of the hydraulic balancing line  $D \sim 0.63 \text{ m}$

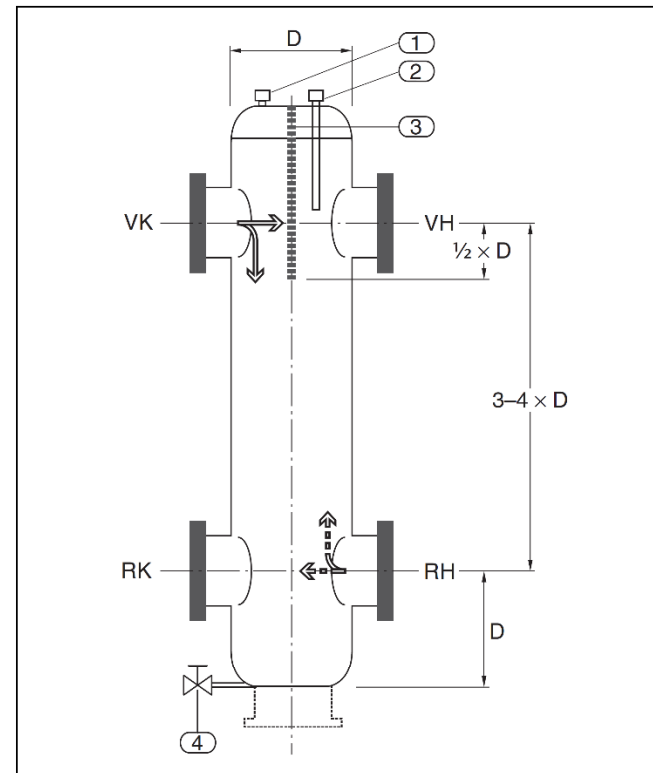

*Main diagram of a low loss header*

RH	Heating system return
RK	Return
VH	Heating system flow
VK	Flow

- [1] Female connection for an air vent valve
- [2] Female connection for a sensor well 1/2 "
- [3] Perforated partition
- [4] Quick-acting valve